



Shingled Cell



Black Backsheet
Black Frame



Residential

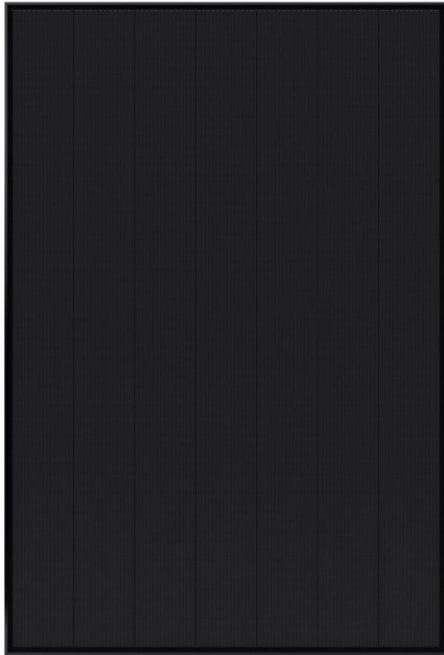

PERFORMANCE 3 BLK

POWER RANGE: 370 - 390 W

With a sleek black design that elegantly blends into any roof, the third-generation SunPower Performance 3 panel combines enhanced warranty terms with an expanded active cell area that delivers increased power and efficiency over previous generation panels.

Backed by an industry-leading warranty and an estimated 35-year useful life,¹ SunPower Performance panels wrap conventional front contact cells with 35 years of materials, engineering and manufacturing expertise to mitigate the reliability challenges of Conventional Panel design.

Engineered for Performance

- Smaller cells stay cooler when shaded, extending panel life⁴
- Advanced encapsulant minimizes degradation from environmental exposure
- Conductive adhesive defends against daily temperature swings
- Redundant cell connections create flexible paths for continuous electricity flow

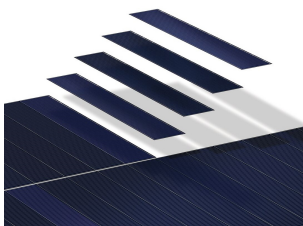

Durability that Translates to More Energy

Engineered to stand up to environmental stresses such as shading, daily temperature swings and high humidity, the SunPower Performance 3 panel delivers up to 7% more energy in the same space over 25 years compared to Conventional mono PERC Panels.²

A Track Record of Innovation Leadership

SunPower Performance panels represent the most deployed shingled cell panel in the industry—innovation protected by a growing portfolio of patents worldwide.³



4+ GW
Deployed



60+
Countries



90+
Patents

A Better Product. A Better Warranty.

Each SunPower Performance panel is manufactured with the confidence to deliver more energy and reliability over time—and backed for 25 years by the SunPower Complete Confidence Panel Warranty.

- Year 1 Minimum Warranted Power Output 98.0%
- Maximum Annual Degradation 0.45%
- Year 25 Minimum Warranted Power Output 87.2%

PERFORMANCE 3 BLK POWER: 370 - 390 W

Electrical Data					
Model	SPR-P3-390-BLK	SPR-P3-385-BLK	SPR-P3-380-BLK	SPR-P3-375-BLK	SPR-P3-370-BLK
Nominal Power (P _{nom}) ⁵	390 W	385 W	380 W	375 W	370 W
Power Tolerance	+5/-0%	+5/-0%	+5/-0%	+5/-0%	+5/-0%
Efficiency	19.9%	19.6%	19.4%	19.1%	18.9%
Rated Voltage (V _{mpp})	36.7 V	36.3 V	35.9 V	35.5 V	35.1 V
Rated Current (I _{mpp})	10.63 A	10.61 A	10.59 A	10.57 A	10.55 A
Open-Circuit Voltage (V _{oc}) (+/-3%)	44.0 V	43.7 V	43.4 V	42.9 V	42.3 V
Short-Circuit Current (I _{sc}) (+/-3%)	11.35 A	11.31 A	11.28 A	11.26 A	11.24 A
Maximum System Voltage	1000 V IEC				
Maximum Series Fuse	18 A				
Power Temp. Coef.	-0.34% / °C				
Voltage Temp. Coef.	-0.28% / °C				
Current Temp. Coef.	0.06% / °C				

Tests And Certifications	
Standard Tests ⁶	IEC 61215, IEC 61730
Quality Certs	ISO 9001:2008, ISO 14001:2004
EHS Compliance	OHSAS 18001:2007, Recycling Scheme
Ammonia Test	IEC 62716
Desert Test	MIL-STD-810G
Salt Spray Test	IEC 61701 (maximum severity)
PID Test	IEC 62804
Available Listings	TUV

Operating Condition And Mechanical Data	
Temperature	-40°C to +85°C
Impact Resistance	25 mm diameter hail at 23 m/s
Solar Cells	Monocrystalline PERC
Tempered Glass	High-transmission tempered anti-reflective
Junction Box	IP-67, Stäubli MC4, 3 bypass diodes
Weight	21.0 kg
Max. Load	Wind: 2400 Pa, 245 kg/m ² front & back Snow: 5400 Pa, 550 kg/m ² front
Frame	Class 1 black anodized

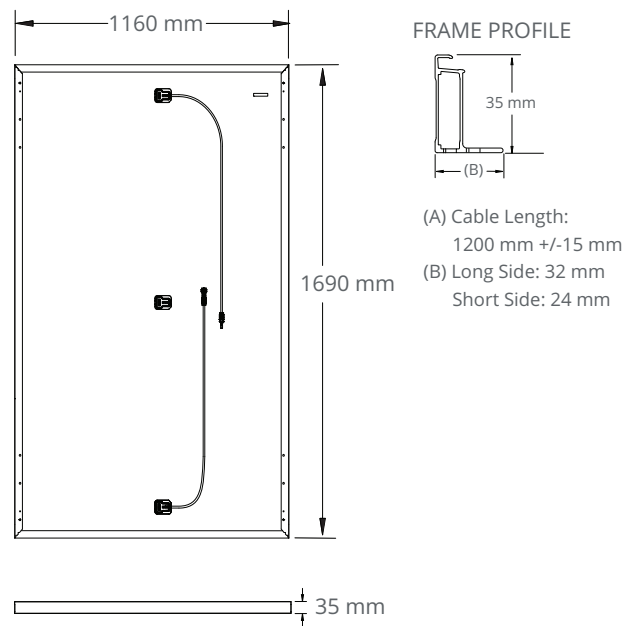

1 Performance panels expected useful life of 35 years. Source: "SunPower P-Series Technology Technical Review," Leidos Independent Engineer Report. 2016.

2 SunPower 390 W, 19.9% efficient, compared to a Conventional Panel on same-sized arrays (310 W mono PERC, 19% efficient, approx. 1.64 m²), 1% more energy per watt (based on PVSIM runs for avg EU climate), 0.1%/yr slower degradation rate (Based on Oct. 2020 review of warranties on manufacturer websites for top 20 manufacturers per IHS 2020).

3 Osborne. "SunPower supplying P-Series modules to a 125MW NextEra project." PV-Tech.org. March 2017.

4 SunPower Performance Series – Thermal Performance, Z.Campeau 2016.

5 Measured at Standard Test Conditions (STC): irradiance of 1000 W/m², AM 1.5, and cell temperature 25° C.

6 Class C fire rating per IEC 61730.

Designed in U.S.A. by SunPower Corporation
 Assembled in China

Specifications included in this datasheet are subject to change without notice.

© 2020 Maxeon Solar Technologies, Ltd. All Rights Reserved. View warranty, patent and trademark information at maxeon.com/legal.

Please read the safety and installation guide.

SUNPOWER
 FROM MAXEON SOLAR TECHNOLOGIES